

**Desk Typical Section at (Y-Y)**

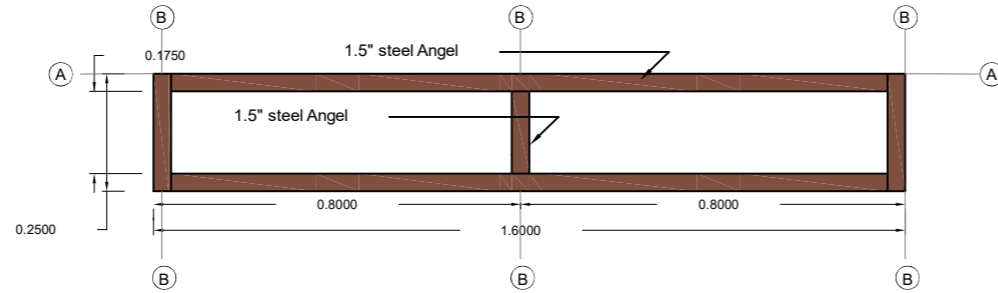

**Seat Typical Plan without Steel Plate**

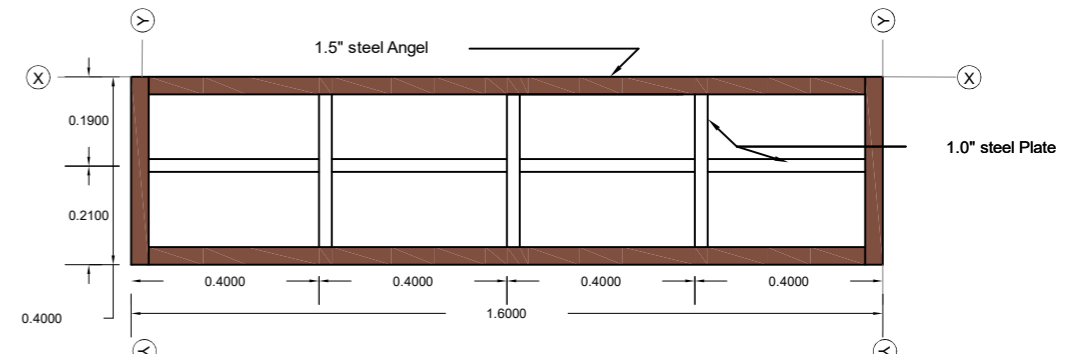

**Desk Typical Plan below steel sheet**

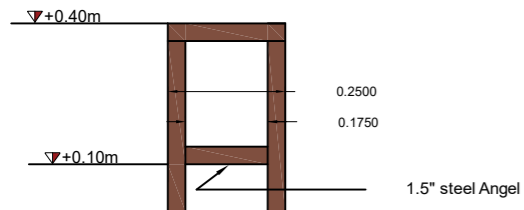

**Seat Typical Section at (B-B)**

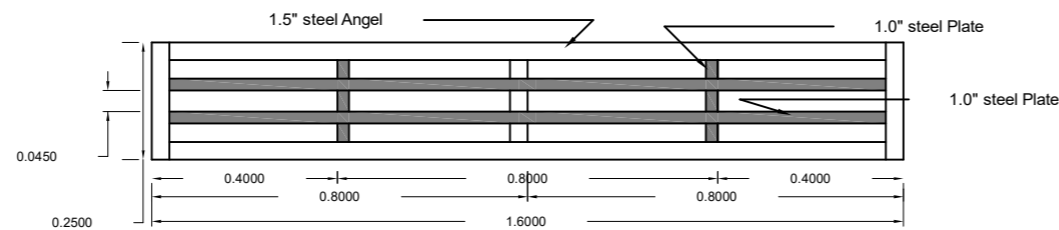

**Seat Typical Plan with Steel Plate**

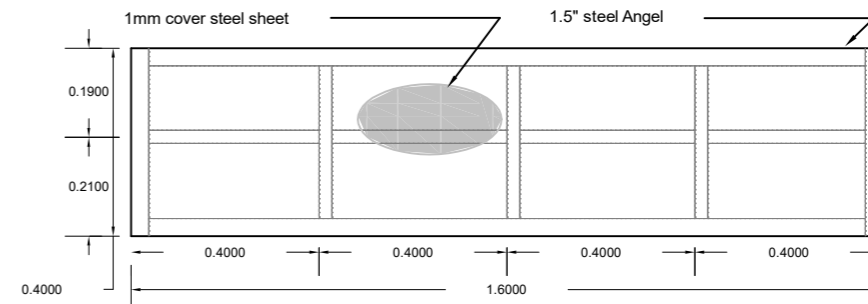

**Desk Typical Plan At Top**

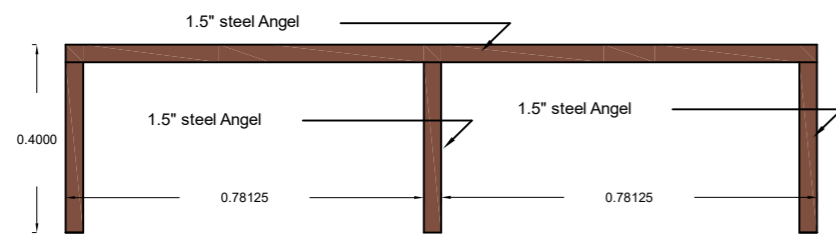

**Seat Typical Section at (A-A)**

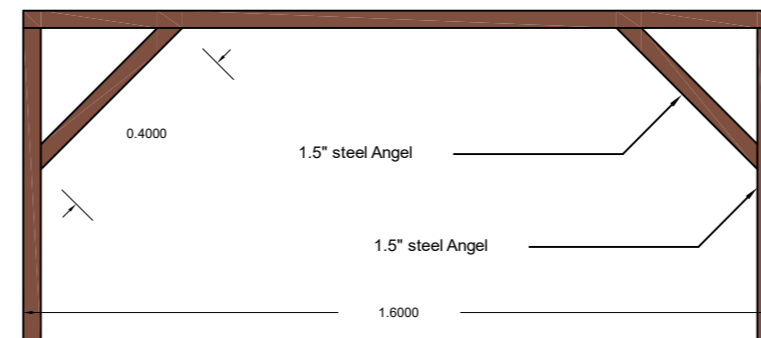

**Desk Typical Section at (X-X)**

Project Name: School Improvement Plan
Project Title: Steel Seat and Desks for schools
Project Location: Different Schools - White Nile
Design by: Mohammed Mahmoud
Drawing name: Plans and Sections
Issue Date: April 2022
Sheet No: 1 Rev. No: 1
Scale: 75:1

